

XTO SQUARE - Pole-mounted - 4941 to 9882 lm
831-1305-HT XTO Square Top 16 LED 32W 3000K lantern IP66 CLII

Spigot: Ø76 H75mm

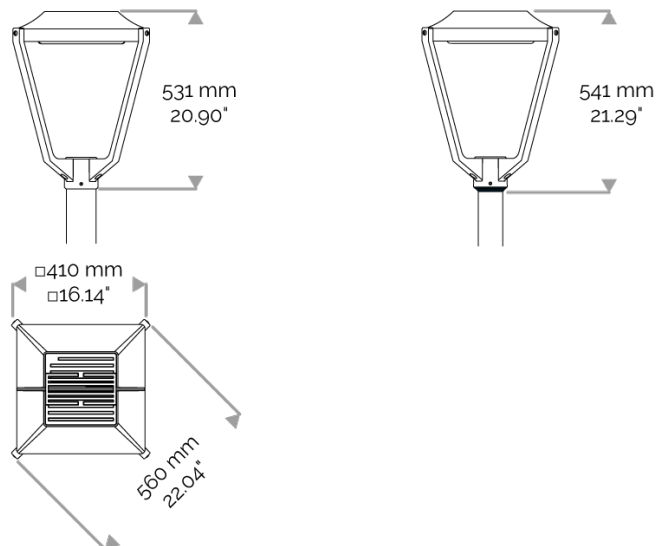

XTO SQUARE - Pole-mounted - 4941 to 9882 lm 831-1305-HT XTO Square Top 16 LED 32W 3000K lantern IP66 CLII

APPLICATION

LED street luminaire, 4 supports, post-top mounting. Urban lighting : Roads, streets, squares, car parks. ULR = 0%.



LIGHTING FEATURES

CRI70. Single circuit or combined circuit. The direction of the LED light output is to be specified when ordering (forward throw or back throw). Cluster optics to be determined by application:

16 LED optics cluster – STREET (831-9095 : 2200K & 2700K) (831-9030 : 3000K & 4000K).

Medium width road lighting. Spacing up to 5.5 times the height of the light source, lighting to the front up to 1.2 times the height.

16 LED optics cluster – ASYMMETRIC FORWARD THROW (831-9145 : 2200K & 2700K) (831-9035 : 3000K & 4000K). Asymmetric lighting for wide roads. Spacing up to 3.5 times the height of the light source, lighting to the front up to 2 times the height.

16 LED optics cluster – PARK (831-9150 : 2200K & 2700K) (831-9040 : 3000K & 4000K). symmetrical lighting, for squares, car parks and park areas. Spacing up to 5.5 times the height of the light source.

8 LED optics cluster – WALK (831-9045). Spacing up to 4.5 times the height of the light source, lighting to the front up to 1.2 times the height.



ELECTRICAL FEATURES

230V AC (except for the USA) mains connection. Integrated driver & 700mA power supply. Built-in 10 kV lightning and surge protection. Cable is not visible. Cable length to be specified in meters when ordering. Control to be specified when ordering (integrated DALI driver, CLO (constant light output), AstroDIM, MainsDIM, StepDIM). Maximum ambient temperature: 30°C. For the USA please consult us.

Lifetime: 100 000 hours L80 B10

CABLES USED

For class I (AstroDIM, StepDIM, MainsDIM): HO7RN-F 5G1,5mm² cable (blue, brown, green/yellow, grey, black).

For class I (StepDIM): HO7RN-F 4G1,5mm² cable (grey, brown, green/yellow, black).

For class II (AstroDIM, StepDIM, MainsDIM): 4x1,5mm² cable (blue, brown, grey, black).

MECHANICAL FEATURES

IP66, IK08. Integrated heat sink. Die-cast aluminium alloy, anti-corrosion treatment prior topolyester powder coating. Hinges allow for the luminaire to be easy opened. Captive stainless steeltorx fasteners with a Delta Seal® treatment to reduce galvanic corrosion. RAL colour to be specified when ordering. Wind pressure = 0.036m². Weight: 14,5 kg.

STANDARDS

Luminaire compliant with European standard EN60598.

MAINTENANCE

Interchangeable LED modules

WARRANTY

5-year warranty: on LED module and driver (see the FLUX conditions).

LUMEN DATA

Lumen nominal total warm white 3000K (lm)	4692
lm/W LED warm white 3000K	148
lm/W product warm white 3000K	125
Qty LED	16
Ta max.	50°C
Tj (at 25°C)	85°C

INRUSH CURRENT

Inrush Current (A)	26
Inrush Current Time (µs)	180

POWER

Product Led Power (W)	31,7
Product Power (W)	37,5